



GenA™ Pager User Manual

(For Pager v2)



Document Version 03/23

Table of Contents

PURPOSE.....	3
GENA VERSION 2 UPDATES.....	3
DEVICE FEATURES.....	4
DEVICE DESIGN.....	5
Mechanical Features.....	5
Button Locations.....	5
Battery Insertion and Removal.....	5
DESCRIPTION OF SCREEN ICONS, INDICATORS & WARNINGS.....	6
INTERFACE BUTTONS.....	7
MAIN DEVICE SCREENS.....	8
TURNING THE PAGER ON AND OFF.....	9
Turning the Pager On.....	9
Turning the Pager Off.....	9
SPECIAL POWER OFF SCREENS.....	10
FRONT LIGHT.....	10
MAIN SCREEN.....	10
Main Screen Folders.....	11
Bottom Row Status Icons.....	11
MESSAGE OPERATIONS.....	12
Receiving a Message.....	12
Message List Screen (Inbox and Groups Folders).....	12
Message List Screen.....	12
Message List Action Popup.....	13
Message Auto-Delete Behavior.....	14
Message List Screen (Saved Folder).....	14
Message List Screen.....	14
Message List Action Popup (Saved Folder).....	15
Message Read Screen (Inbox, Groups and Saved).....	16
Inbox/Groups/Saved Message Read Screens.....	16
Read Message Screen Navigation.....	16
Read Message Action Popup.....	17
Group Folder Sub-Folder Screen (Groups).....	18
SETTINGS.....	19
Quiet Mode.....	20
Date & Time.....	21
Alarm.....	22
Folder Alerts.....	23
Inbox Alert and Folder Alerts Indicators.....	23
Global Settings Option.....	23
Set Folder Alerts Screens.....	23
Set Message Font Size.....	26
Set Lock Code.....	26
Do Not Disturb.....	29
Key Vibe.....	30
Message Folder Size.....	30
On-line Support.....	32
About.....	32

PURPOSE

This user manual is intended to provide detailed user interface and operating instructions for the Spok GenA™ version 2 pager. The premium GenA™ pager is offered exclusively by Spok.

GENA VERSION 2 UPDATES

The GenA version 2 pager has the following user interface updates.

- Complete group alert control
 - The original GenA pager already had expanded alert flexibility that allowed each group address folder to have different alert. However, the flash and reminder alert settings were global for all addresses.
 - The GenA v2 allows the flash and reminder alerts to be enabled/disabled for the Inbox and each Groups folder. In addition, each group folder alert can be set up for continuous alerting.
- Expanded message folder size control
 - The original GenA pager supports up to 99 messages in the inbox and the groups folder. The folder size setting is global across the inbox and group folders.
 - The GenA v2 allows the inbox and group folder message sizes to be individually set. Now you can keep a long message history for one folder and only keep a few messages for another. The groups and saved folders have a combined 99 message capacity.
- Other small improvements
 - Added 'Delete All Msgs' selection to message list screen action popup
 - Added on-line access option. Scan QR code with a smartphone to access support documentation
 - Display Time screen with Escape button press at main screen
 - Display Logo Graphic and Screen Name with Up button press from the Main screen
 - Settings menu title updates

DEVICE FEATURES

- Device
 - High resolution e-Paper display with auto-on front-light
 - 16 Flex long/short address capacity
 - Powered with one alkaline AA battery
 - Antimicrobial holster and device case & lens
- Main Screen Status
 - New message indication (Message Icon)
 - Unread message count badges for Inbox and Groups folders
 - Four segment battery status
 - User screen name
- Message Management
 - 20, 40, 60, 80 & 99 Inbox folder message size options*
 - 20, 40, 60, 80 & 99 Groups folder message size across all sub-folders and Saved folder*
 - 25 Saved folder message size (from Groups folder message allocation)*
 - Inbox and Groups folder message lock with Lock icon
 - Up to 15 groups sub-folders (optional)
 - Message with time & date stamp
 - Message continuation icon
 - All & individual message delete
 - Message slot number and source text
 - Duplicate message indication (with icon)
 - Message actions: Delete All Msgs*, Delete Read Msgs, Delete, Save & Lock
- Configuration Settings
 - 5, 6, 7 & 10 line message text display with proportional font
 - Quiet Mode (user selectable)
 - One-time or daily alarm
 - Complete Inbox and Groups Folder alerts control*:
 - One beep, one standard and seven custom alerts, chirp, vibrate
 - Flash alert by sub-folder
 - 2-minute reminder alert by sub-folder
 - Continuous alert by sub-folder
 - Do Not Disturb time (no audible alert)
 - User power On/Off
- Remote Programming with Spok MyAccount portal
 - Access lock clear
 - Message and encryption key delete
 - Screen name update
 - Group address add/delete and sync
- Other
 - Always-On digital clock display
 - Custom power up logo (Optional)
 - Message AES-128 encryption (Optional)
 - Screen power-off indication with confidential message protection

* New feature for GenA v2

DEVICE DESIGN

Mechanical Features

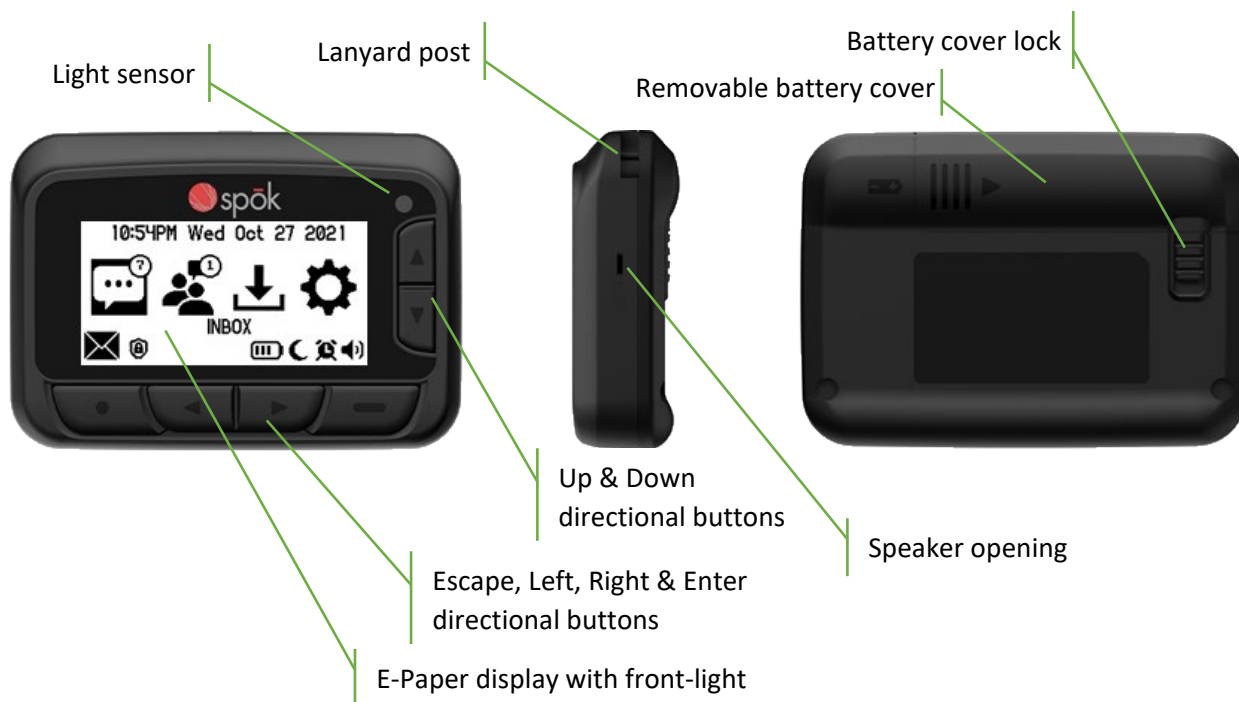

Button Locations

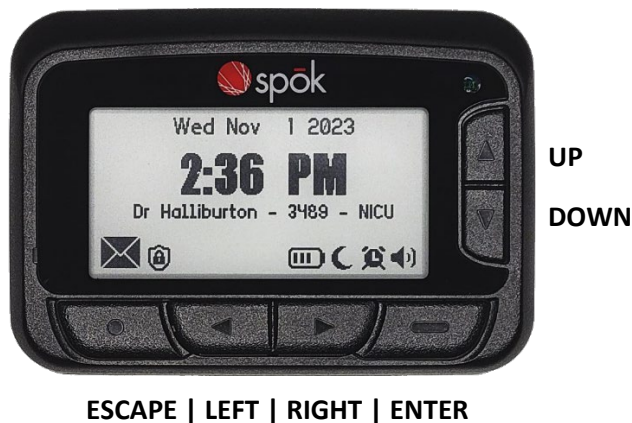

Battery Insertion and Removal

- Hold the pager face down and slide the battery cover lock away from the battery cover
- Slide the battery cover in the direction of the arrow about ¼" out until the two alignment dots are lined up. Then lift the cover away from the pager housing
- Insert a AA alkaline battery with the negative end to the spring contact
- Replace the battery cover by inserting and aligning the dots. Then slide the cover closed and move the battery cover lock into place













DESCRIPTION OF SCREEN ICONS, INDICATORS & WARNINGS



Main Screen Folder Icons

	Inbox		Saved
	Groups		Settings

Main and Time Screen Status Icons (Bottom Row)

	Inbox Audio Alert		New Message
	Inbox Vibration Alert		Full Encrypted Message Support
	Inbox Disabled Alert (Silent)		Do Not Disturb Active
	Alarm Enabled		
	Battery Status - Full Battery		Battery Status - 2/4 Battery
	Battery Status - 3/4 Battery		Battery Status - 1/4 Battery
	Battery Status - Low Battery		

General Navigation Indicators

	Current Setting		Before Page
			Next Page

Message Status Icons

	Unread Message		Duplicate Message
	Locked Message		Unread Duplicate Message
	Unread Locked Message		

Low Battery Warnings

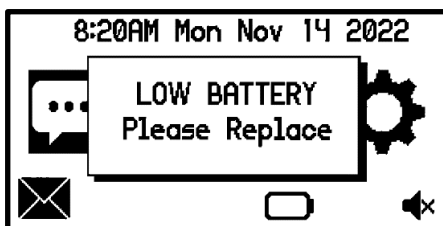
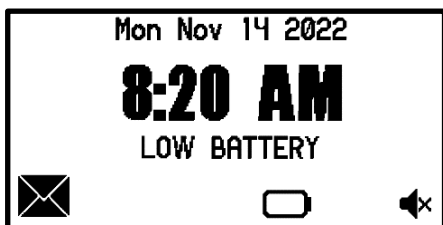





When the AA alkaline battery level drops to zero segments, the battery should be immediately replaced before the pager shuts down. The pager will show the following low battery warnings.



- 'LOW BATTERY' reminder text will appear on the Time screen
- A 'LOW BATTERY / Please Replace' popup will appear on the Main screen. Pressing any button will clear the popup
- An audible chirp will sound at the top of each hour (unless Do Not Disturb is active)

When the battery level drops lower, the pager will power off and display 'DEAD BATTERY'.

INTERFACE BUTTONS

BUTTON	FUNCTIONS
<p>Left and Right</p> 	<ul style="list-style-type: none"> • Used to move a selection highlight left or right. • Used to navigate through the Settings menu items. • Used to move the previous/next page in message list screen. • Used to move the previous/next message in message view screen. • Used to navigate through Date & time, alarm and Do not disturb time setting values.
<p>Enter</p> 	<ul style="list-style-type: none"> • Used to open an action popup (with 2 sec press). • Used to open a message from a message list screen. • Used to activate a highlighted selection. • Used to move to the next page of a message when in the message view screen. • Used to confirm adjusted Date & time, Alarm and Do not disturb time setting value changes.
<p>Escape</p> 	<ul style="list-style-type: none"> • Used to exit a menu or a menu popup. • Used to cancel a selection. • Used to turn the front light on with a 2 sec press. • Used to return to the Time Display screen from the Main screen
<p>Up and Down</p> 	<ul style="list-style-type: none"> • Used to move Up and Down a list. • Used to move Up and Down the Settings menu and through a message list screen. • Used to move Up or Down a message line by line in a message view screen. • Used to change values in the Date & time, Alarm and Do not disturb time setting values.

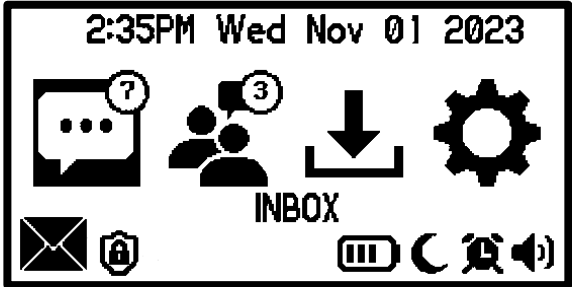
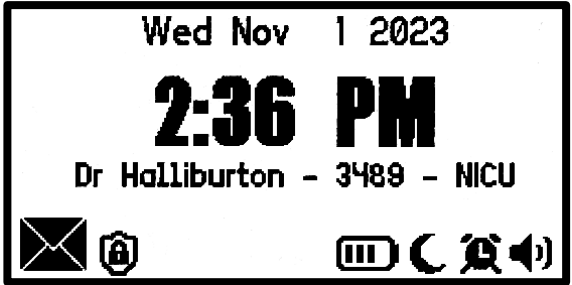
MAIN DEVICE SCREENS

SCREEN	NOTES
 <p>The image shows a rectangular screen with a black border. At the top, it reads "SPOK WIRELESS" in bold, followed by "Dr. John Smith" in a smaller font. Below the text is a circular logo with a globe-like pattern and the word "spok" in a stylized, lowercase font.</p>	<p><u>Power-up Screen</u></p> <p>This screen shows the screen name and a logo graphic. It will appear briefly when the pager is turning on and when the Up button is pressed from the Main screen.</p>
 <p>The image shows a rectangular screen with a black border. At the top, it displays the time and date: "2:35PM Wed Nov 01 2023". Below this are four icons: a speech bubble with a question mark, a group of people with a '3', a download arrow, and a gear. The word "INBOX" is centered below these icons. At the bottom, there are status icons: an envelope, a lock, a battery level indicator, a moon, and a speaker.</p>	<p><u>Main Screen</u></p> <p>This screen will appear after the pager turns on or when the user exits the Inbox, Groups, Saved or Settings list or when the user presses a button while on the Time screen.</p> <ul style="list-style-type: none"> • The screen shows the current time & date at the top • The Inbox, Groups (if enabled), Saved and Settings folder icons are shown in the middle • The bottom row shows the status icons
 <p>The image shows a rectangular screen with a black border. At the top, it displays the date: "Wed Nov 1 2023". Below this is the time "2:36 PM" in a large, bold font. Underneath is the screen name: "Dr Halliburton - 3489 - NICU". At the bottom, there are status icons: an envelope, a lock, a battery level indicator, a moon, and a speaker.</p>	<p><u>Time Screen</u></p> <ul style="list-style-type: none"> • This screen automatically appears after the user hasn't pressed a button for 30 seconds and will stay on continuously until a button is pressed • The date and time, the device screen name, and the device status icons in the bottom row are shown • The screen can be immediately displayed when the  button is pressed from the Main screen

TURNING THE PAGER ON AND OFF

Turning the Pager On

- If the pager has a good battery but was switched off, press the Enter button for 2-3 seconds
- If the pager doesn't have a battery, insert a fresh battery and it will turn on automatically
- If the pager battery depleted, replace with a fresh battery and it will turn on automatically

IMPORTANT: The pager has an internal power reservoir. If the reservoir is depleted when a new battery is inserted, it may take up to 15 seconds before the pager can turn on.

Turning the Pager Off

SCREEN



NOTES

Main Screen

- Press any button to display the Main screen
- Press the Left or Right buttons to move the highlight to the Settings icon and press the Enter button to go into the Settings list screen

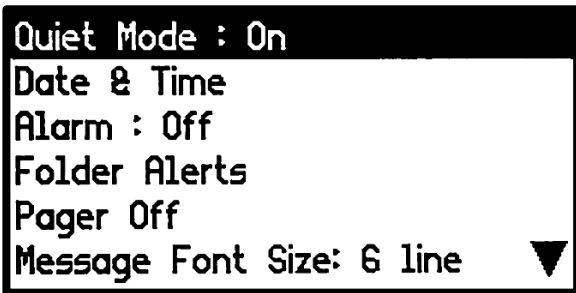

Settings Folder Screen

- Press the Down button to move the highlight to the Pager Off item and press the Enter button

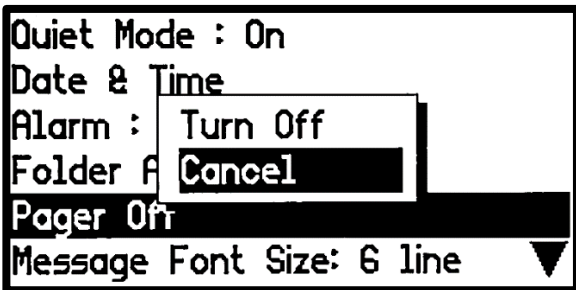

Turn Off Popup

- Press the Up button to select Turn Off and press the Enter button to turn off the pager
- The Pager Off screen will appear

SPECIAL POWER OFF SCREENS

E-Paper screens permanently display their last image when power is removed. To ensure that personal or confidential information that may be in a message is cleared from the display when the pager is powered off, the GenA pager will automatically update its screen when it is turned off, the battery is removed, or the battery dies while still inside the pager. In these situations, text on the pager will indicate how it was powered off so that the user will clearly know how to turn the pager on again.



FRONT LIGHT



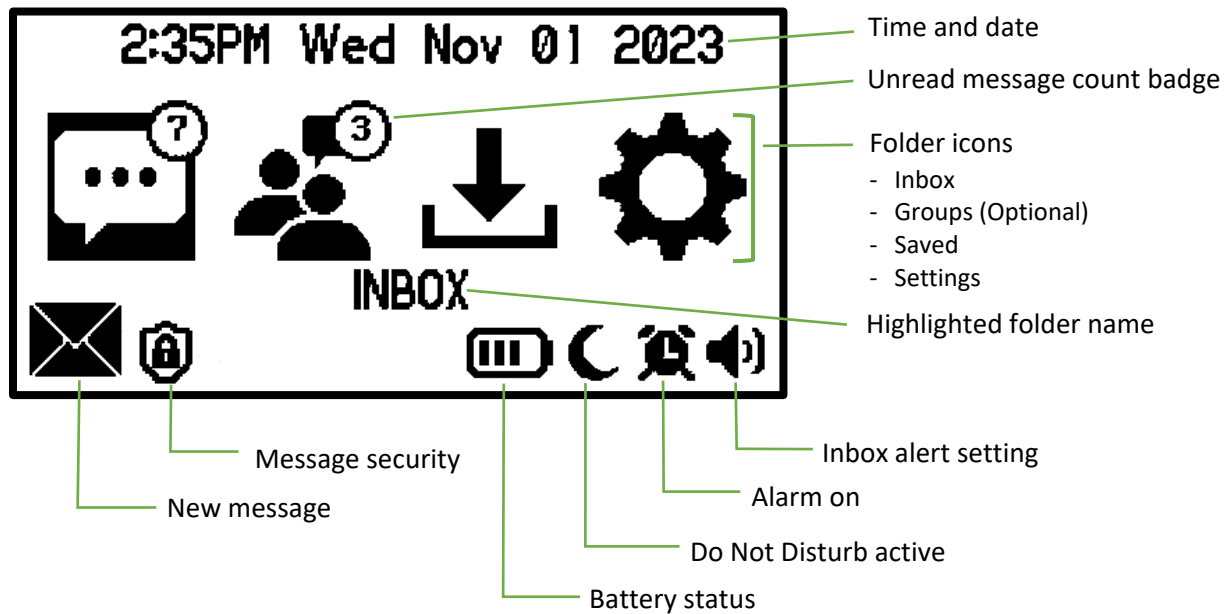

In low-light conditions, the pager’s front light automatically turns on whenever a button is pressed. The front light will automatically turn off 10 seconds after the last button press.

MAIN SCREEN



























Press the or buttons to move the highlight between the Inbox, Group, Saved and Settings folders. Press the button to select the highlighted folder icon.

Main Screen Folders

FOLDER NAME	ICON	NOTES
Inbox		<ul style="list-style-type: none"> Personal messages appear in this folder A badge will appear on the icon to show the number of unread messages in the Inbox folder
Groups		<ul style="list-style-type: none"> Group messages appear in this folder A badge will appear on the icon to show the number of unread messages in the Groups sub-folder(s) The folder icon is not visible if group address sub-folders aren't programmed in the pager
Saved		<ul style="list-style-type: none"> Any saved messages appear in the Saved folder Messages are sorted in the order they were saved
Settings		<ul style="list-style-type: none"> Device settings can be viewed and updated within the Settings folder

Bottom Row Status Icons

STATUS	ICON(S)	NOTES														
New Message		<ul style="list-style-type: none"> Appears when a new message is received in either the Inbox or a Groups folder. Is disappears when the message list screen is opened for the use to read the message preview 														
Message Security		<ul style="list-style-type: none"> Displays when all programmed pager addresses are encryption-enabled for secure messaging 														
Battery Status		<ul style="list-style-type: none"> Shows the current battery level A low battery popup will appear when the battery needs to be replaced 														
Alarm On		<ul style="list-style-type: none"> Appears when an alarm is enabled The alarm is set up and activated from the Settings folder 														
Do Not Disturb		<ul style="list-style-type: none"> Appears when Do Not Disturb is enabled <u>and</u> currently active The Do Not Disturb feature is set up and enabled from the Settings folder 														
Inbox Audible Alert Setting	 <table border="1" data-bbox="764 1623 1240 1839"> <thead> <tr> <th rowspan="2">INBOX ALERT SETTING</th> <th colspan="2">QUIET MODE</th> </tr> <tr> <th>ON</th> <th>OFF</th> </tr> </thead> <tbody> <tr> <td>Audible</td> <td></td> <td></td> </tr> <tr> <td>Vibrate</td> <td></td> <td></td> </tr> <tr> <td>Silent</td> <td></td> <td></td> </tr> </tbody> </table>	INBOX ALERT SETTING	QUIET MODE		ON	OFF	Audible			Vibrate			Silent			<ul style="list-style-type: none"> Shows the current Inbox audible alert setting. On, vibrate or off The table below shows how the Quiet Mode setting and the Inbox alert setting combine to impact the status icon The folder alerts are set up from the Settings folder
INBOX ALERT SETTING	QUIET MODE															
	ON	OFF														
Audible																
Vibrate																
Silent																

MESSAGE OPERATIONS

Receiving a Message

When the pager receives a message into the Inbox or a Groups folder, it will alert based on the configured alert settings and will open the Message list screen with the newly received message highlighted. Pressing the Enter button will silence the alert and open the message in the Message view screen for immediate reading.

If the message isn't immediately read, the display will return to the Main screen and later to the Time screen. The New Message icon will appear at the left side of the bottom row of the Main and Time screens.

Message List Screen (Inbox and Groups Folders)

The message list screen displays a list of all the messages in the folder. The list shows a preview of each message, and the highlighted message will open when the Enter button is pressed. The highlight is moved up or down one message at a time by pressing the up and down buttons. The highlight is moved up or down one page at a time by pressing the left and right buttons. The Inbox and Groups Folders hold 20 messages each by default, but this can be increased to 40, 60, 80 and 99 messages. Pressing the Enter button for one second will bring up an action popup where various message management functions can be selected.

Message List Screen

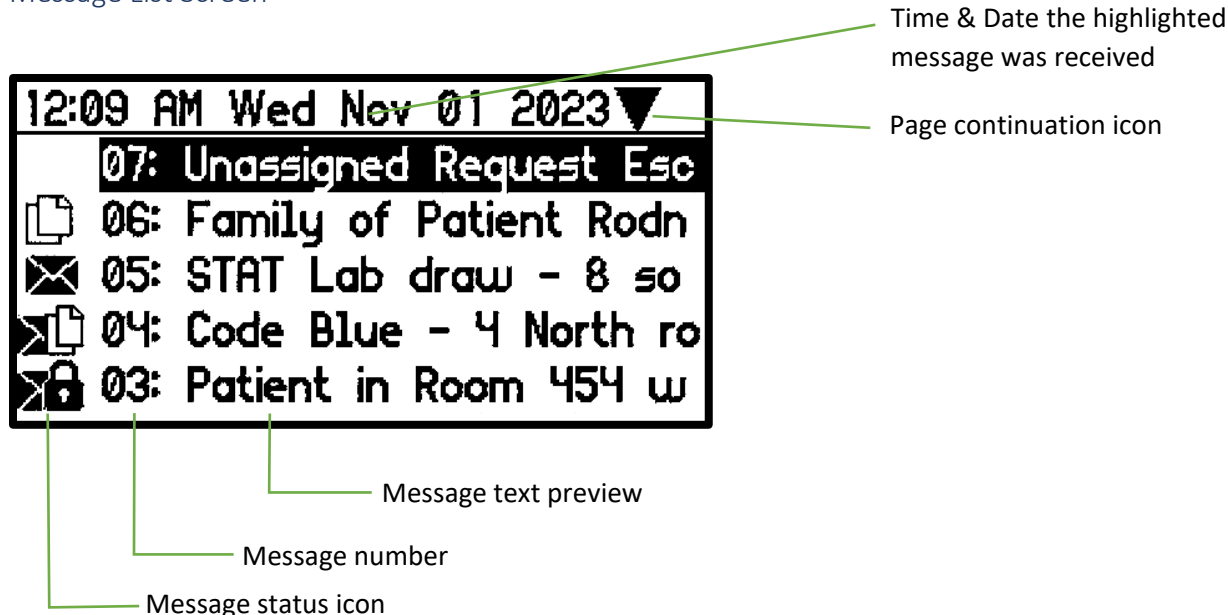

Message status icons are described below:

MESSAGE STATUS	ICON(S)	NOTES
Unread		<ul style="list-style-type: none"> The message has not been read
Read	<Blank>	<ul style="list-style-type: none"> The message has been read
Locked		<ul style="list-style-type: none"> The message has been locked to prevent deletion or from being replaced when memory is full. Up to half of max message number can be locked
Unread & Locked		<ul style="list-style-type: none"> The message has not been read but has been locked to prevent accidental deletion

MESSAGE STATUS	ICON(S)	NOTES
Unread & Duplicate		<ul style="list-style-type: none"> The message has not been read and is a duplicate When a duplicate message is received, the original previous message is deleted so only the recent message is kept in memory
Duplicate		<ul style="list-style-type: none"> The read message was a duplicate

- Messages are sorted with the most recently received messages at the top
- The date/time information at the top of the display shows the date/time that the selected message was received by the pager based on the pager’s date/time setting.
- When navigating up and down through the list, the selected message will be highlighted in reverse video.
- The ▼ or ▲ at the upper right indicates that there are more messages below or above that displayed.
- Press the ▲ or ▼ button to move the selection up or down. Pressing ▲ or ▼ when at the top or bottom of the list will move the selection to the bottom or top of the list respectively (wrap-around).
- Press the ◀ or ▶ button to move the message list up or down page by page. Pressing ◀ or ▶ when at the top or bottom of the list will move the selection to the bottom or top respectively (wrap-around).
- Press the [] button to view the message in the message read screen.
- Press the [] button for 2 sec, to bring up the message list popup.

Message List Action Popup

When the Enter button is pressed for 2 seconds on a highlighted message, an action popup appears. The action popup displays actions that can be performed on a highlighted message or within the message list.

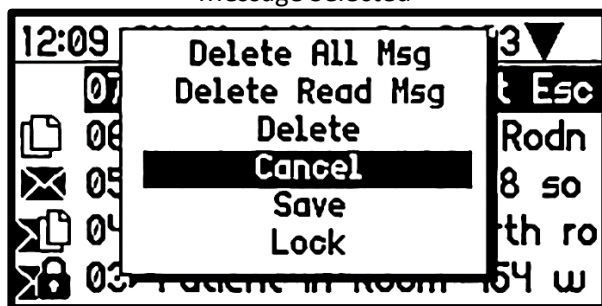

Action Popup with an Unread or read Message Selected

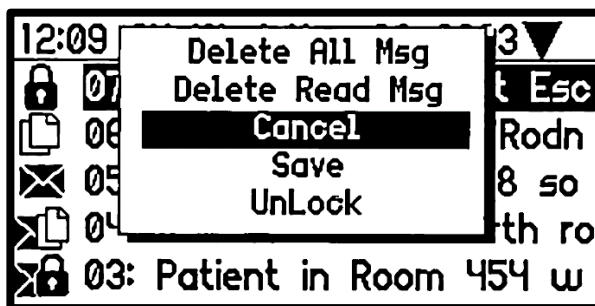

Action Popup with a Locked Message Selected



ACTION	DESCRIPTION
Delete All Msg	All read and unread messages are deleted. Locked messages are <u>not</u> deleted.
Delete Read Msg	All read messages are deleted. Unread and locked messages are <u>not</u> deleted.
Delete	The highlighted message is deleted. If the popup is brought up when a locked message is selected, this action will not appear
Cancel	The action popup is cleared. This item is highlighted by default

ACTION	DESCRIPTION
Save	The highlighted message is moved to the Saved folder and removed from the message list. The Saved folder can hold up to 25 messages. When trying to save a 26 th message, a 'Saved Folder Full' popup will momentarily appear.
Lock / Unlock / Lock Full	<p>Messages can be locked to prevent them from being deleted or from being replaced when memory is full. If the highlighted message is unlocked, its message status icon will change to a Locked  or Unread Locked  icon. If the action popup is brought up when a locked message is selected, the delete action will not appear and an Unlock action will appear. If the Unlock function is selected, the messages' status icon will change to blank to indicate a read message.</p> <ul style="list-style-type: none"> • Up to half of the max message number for the folder can be locked • When the locked message number limit for the folder have been reached, 'Lock Full' will be displayed in the action popup • The saved folder does not have a message lock function

Message Auto-Delete Behavior

When the configured message memory is full for the Inbox or Groups folders, new messages will be automatically deleted to make room for new messages. Read messages will be deleted, oldest first, followed by unread messages, oldest first. Locked messages are not automatically deleted.

With 198 messages allocated between all Groups sub-folders and Saved folder, messages can be automatically deleted from any sub-folder based on message age.

Message List Screen (Saved Folder)

The Saved folder can hold up to 25 messages.

Message List Screen

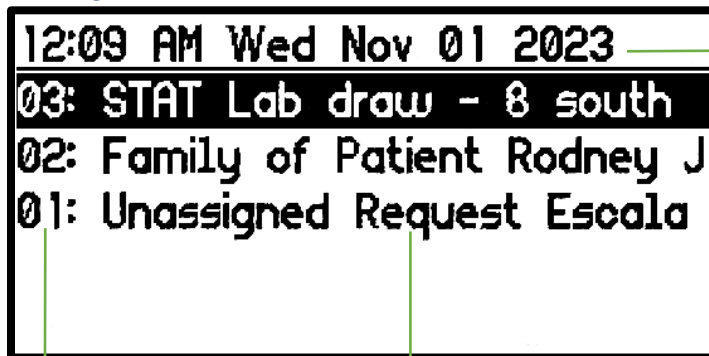

Received time & date of highlighted message

Message #

Message text preview

Message List Action Popup (Saved Folder)

When the Enter button is pressed for 1 second on a highlighted message, an action popup appears. The action popup shows actions that can be performed on the highlighted message.

Action Popup

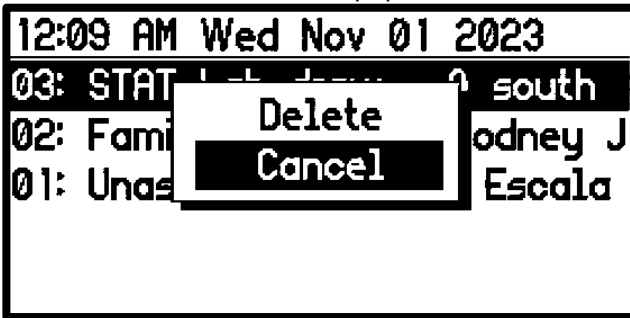

ACTION	DESCRIPTION
Delete	The highlighted message is deleted
Cancel	The action popup is cleared. This item is highlighted by default

Messages are not automatically deleted when the Saved folder is full. If the Saved folder is full (25 messages), messages must be manually deleted to make room for other saved messages.

Message Read Screen (Inbox, Groups and Saved)

The message read screen displays the full message text. Pressing the down or up button moves the text down or up one line at a time. Pressing the Enter button moves the text down one page at a time.





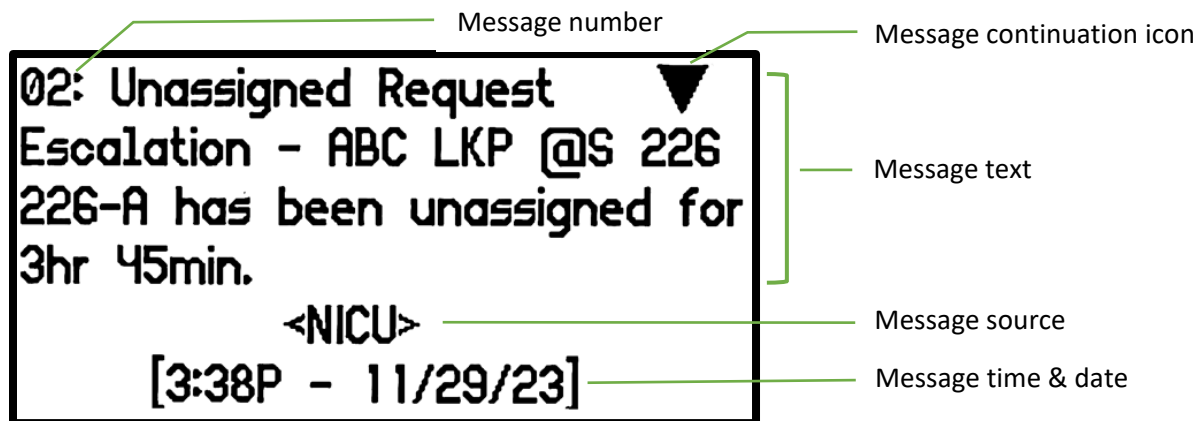

Pressing the Enter button for one second will bring up an action popup where various message management functions can be selected.

Inbox/Groups/Saved Message Read Screens



The Message Read Screen displays the first page of the selected message.

Read Message Screen Navigation

NAVIGATION	BUTTON(S)	NOTES
Line by line	 or 	<ul style="list-style-type: none"> The Up & Down buttons allow the user to move up or down the message text line-by-line
Page by page		<ul style="list-style-type: none"> Pressing the Enter button moves the message text display down page-by-page
Exit		<ul style="list-style-type: none"> Pressing the Escape button returns the user to the message list screen
Message to message	 or 	<ul style="list-style-type: none"> Pressing the Left or Right buttons allow the user to move to the previous or next message

When entering the Message Read Screen of an unread message, the message changes status from unread to read.

When the bottom of the message is reached a ‘Message Options’ selection appears at the bottom of the screen. Pressing Enter again will bring up the message action popup.



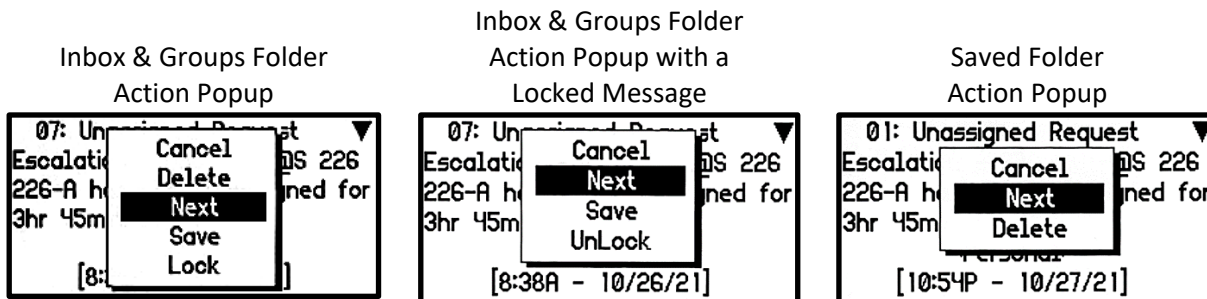

NOTES: The Message Source text that appears below the message content is programmed within the pager. It indicates which pager address the message was received on. The default source text is ‘<#>’.

Read Message Action Popup

When the Enter button is pressed for 2 seconds when viewing a message, an action popup appears. The popup shows actions that can be performed on the message.



ACTION	DESCRIPTION
Cancel	The action popup is cleared. This item is highlighted by default
Delete	The highlighted message is deleted. If the popup is brought up when a locked message is selected, this action will not appear
Next	Displays the next oldest message in the folder
Save	The highlighted message is moved to the Saved folder and removed from the message list. The Saved folder can hold up to 25 messages. When trying to save a 26 th message, a 'Saved Folder Full' popup will momentarily appear.
Lock / Unlock	The highlighted message is locked and its message status icon in the list screen will change to a Locked  icon. If the popup is brought up when a locked message is selected, the delete action will not appear and an unlock action will appear and its message status icon will change to blank to indicate a read message. <ul style="list-style-type: none"> • Up to half of Message Folder Size value can be locked. • The saved folder does not have a lock function.



- Press the  or  button to navigate through the popup menu.
- Press the  button to execute the action.
- Press the  button to cancel the action popup.

Group Folder Sub-Folder Screen (Groups)

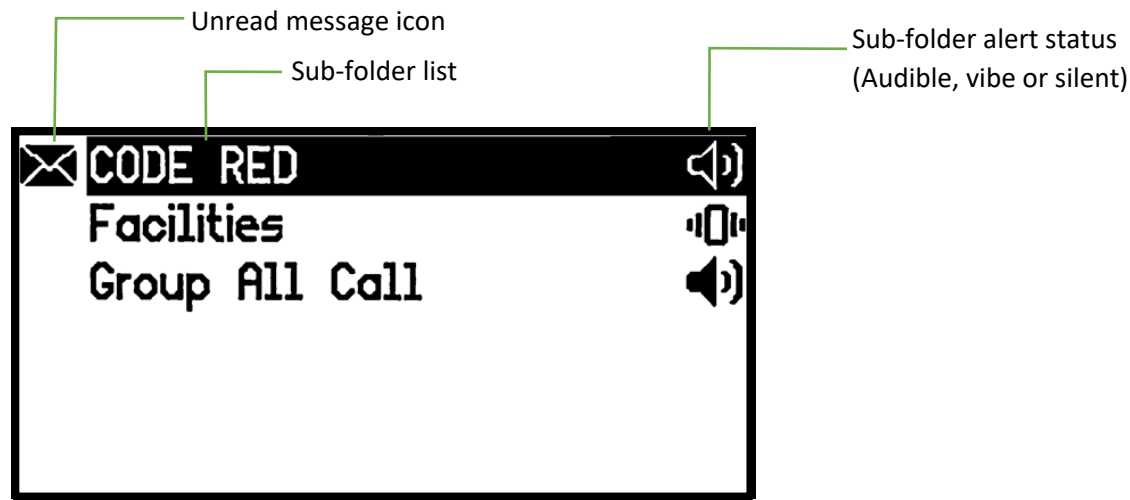

The Groups folder (If enabled within the pager) can contain one or more sub-folders. Each sub-folder contains messages from separate group addresses programmed into the pager. The sub-folder name is programmed in the pager and each sub-folder can be configured by the user with a unique alert.



Group Sub-folders Screen

- Press the  or  button to highlight the desired sub-folder.
- Press the  button to view the messages in the selected sub-folder. If the sub-folder doesn't contain any messages, 'No Messages' will momentarily appear on the screen.

Notes

1. The sub-folder name is determined when the group address is programmed in the pager
2. Sub-folders containing unread messages will display the unread message icon on the left.
3. Different alerts and alert behaviors can be set for each sub-folder. See Folder Alerts item in the Settings folder.
4. The sub-folder audible/vibe/silent alert status is displayed on the right side of the folder according to the set alert. (Audible , Vibe  or Silent )

SETTINGS

The Settings folder provides access to the many features incorporated in the pager. When available, the current setting value is displayed to the right of the menu item for easy reference.

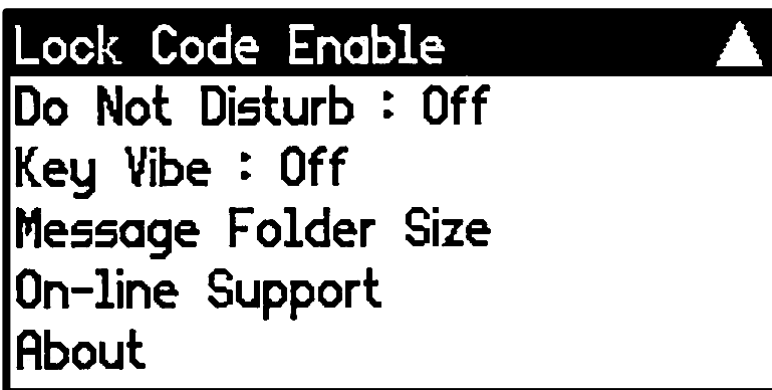
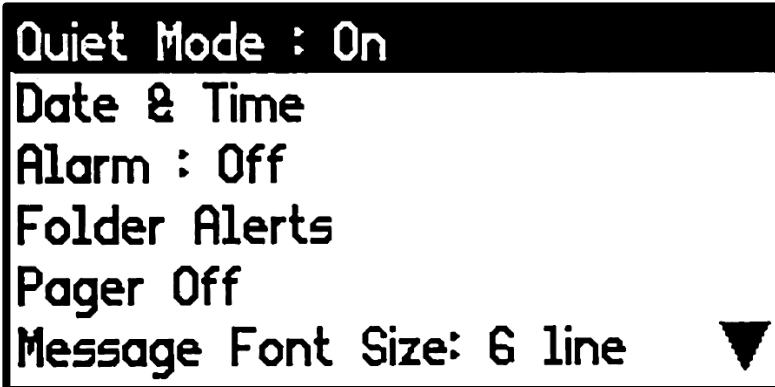

The Lock Now, Lock Code Enable, Change Lock Code and Disable Lock Code items only appear if the optional Lock feature is enabled and activated on the pager.

Quiet Mode

With the Quiet Mode feature, any message and alarm audible alerts are suppressed to vibrate instead.

SCREEN

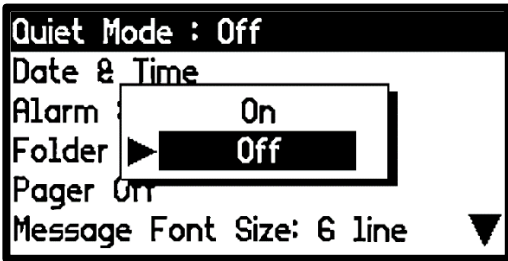







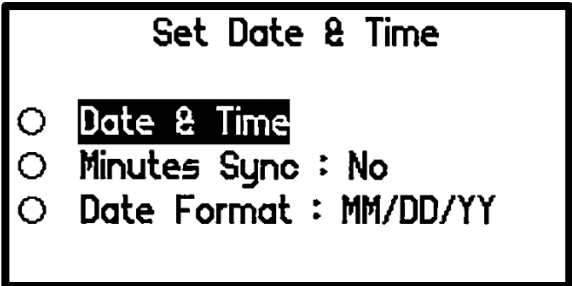

NOTES

Set Quiet Mode Popup

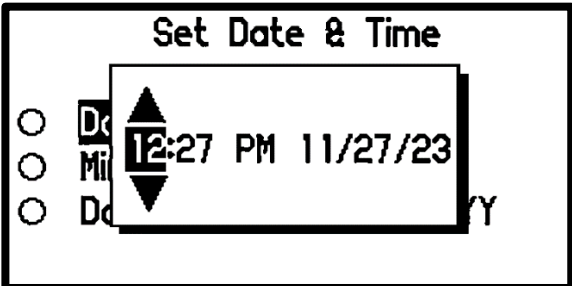
- When setting the Quiet mode to on, all pager audible alerts will vibrate instead. The alert status on the Main screen will show as 
- The current setting is indicated by the  icon
- Any folders set to a Silent alert will remain silent





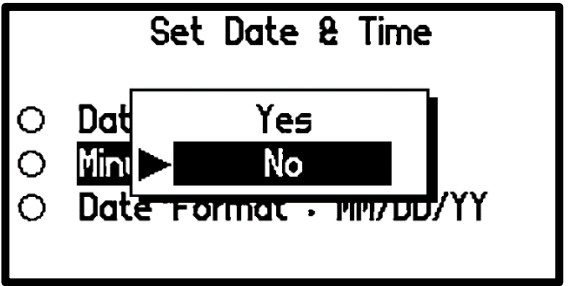
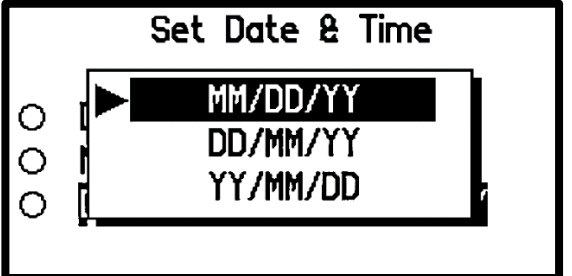



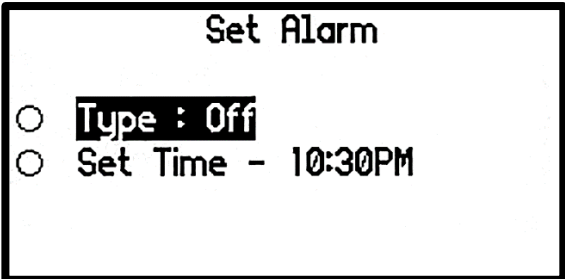

Date & Time

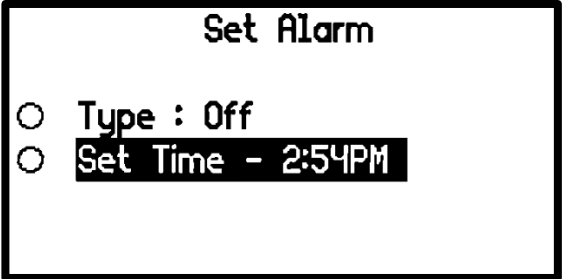
The date and time setting in the pager appears on the Main and Time screens and determines the date and time displayed for when a message was received (The message timestamp).

SCREEN	NOTES
	<p><u>Set Date & Time Menu Screen</u></p> <ul style="list-style-type: none"> Select the option to be updated and press  button
	<p><u>Set Date & Time Screen</u></p> <ul style="list-style-type: none"> Press the  or  button to move through the Time and Date entries Press the  or  button to change Time, AM-PM and Date values Press the  button to accept the updated values and clear the popup Press the  button to cancel the changes and exit to the Set Time & Date menu screen When AM-PM value is set to 24, the time display changes to 24-hour format
	<p><u>Set Minutes Sync Screen</u></p> <ul style="list-style-type: none"> When set to Yes, the pager's clock minutes value is automatically set based on network time The date, hours or AM/PM values of the pager clock must be set by the user
	<p><u>Set Date Format Screen</u></p> <ul style="list-style-type: none"> The format of the date value used throughout the pager can be selected The options are MM/DD/YY, DD/MM/YY and YY/MM/DD

Alarm

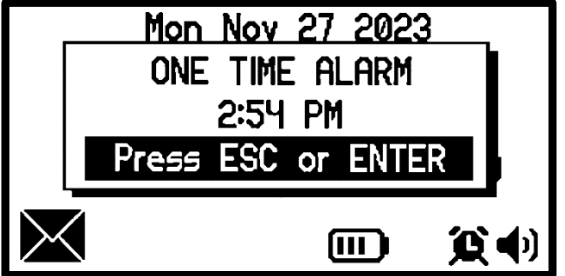
One alarm can be set within the pager. The alarm types are Daily and One Time. Only the alarm time can be set.

SCREEN	NOTES
	<p><u>Set Alarm Screen</u></p> <ul style="list-style-type: none"> Select the Set Alarm option to update and press  button
	<p><u>Set Type Popup</u></p> <ul style="list-style-type: none"> The alarm works daily when set as Daily Alarm only works once when set as One Time When setting a Daily or One Time alarm, the alarm status icon will appear on the Main and Time screens When set to off, the Alarm status icon will not appear on the Main and Time screens
	<p><u>Set Time Popup</u></p> <ul style="list-style-type: none"> Press the  or  button to move through the time and AM/PM values Press the  or  button to increase or decrease the time values and the AM/PM setting Press the  button to set the alarm time value Press the  button to cancel the changes and exit to the Set Alarm menu screen
	<p><u>Alarm Event Screen</u></p> <ul style="list-style-type: none"> When the alarm event occurs, a screen popup will appear, and the alarm sound will be heard The alarm sound will automatically end after 5 minutes You can cancel the alarm by pressing the  or  button

Folder Alerts

Within this setting the individual message alert options for the Inbox and any Groups sub-folders can be independently controlled. The available alert options are listed in the following table.

ALERT OPTION	DESCRIPTION
Type	The paging message alert type can be set to a standard audible alert, a vibrating alert, a chirp alert, a silent alert, or one of seven other audible alerts. All alerts sound for about 15 seconds unless the Continuous Alert option is enabled.
Front Light	<ul style="list-style-type: none"> • Selection options are Flash or No Flash • When setting the Front Light value to Flash, the display's front light will flash along with the alert when a message is received • The front light alert may be useful when in dark environments
Reminder Alert	<ul style="list-style-type: none"> • Selection options are On or Off • When this feature is enabled and there are unread messages, the pager will alert every two minutes with a short double-chirp or vibration, depending on the current alert type or Quiet mode setting
Continuous Alert	<ul style="list-style-type: none"> • Selection options are On or Off • When this feature is enabled, the device will alert continuously until a button is pressed

Inbox Alert and Folder Alerts Indicators

For quick reference, the Inbox audible, vibrate or silent alert setting indicator is shown on the lower right-hand side of the Time and Main screens. The alert setting indicator for each Groups sub-folder is shown at the right side of sub-folder name within the Groups folder.

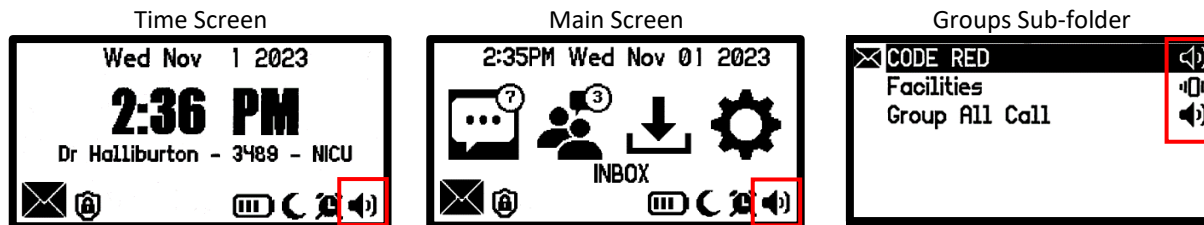

Global Settings Option

If the settings for all folders need to be updated or reset, go to the Global Settings item to apply the same alert options to all folders at once.

Set Folder Alerts Screens



SCREEN	NOTES
<p>The screenshot shows a screen titled 'Set Folder Alerts' with the following settings: <ul style="list-style-type: none"> Inbox : Standard CODE RED : Standard Facilities : Standard Group All Call : Standard Global Settings </p>	<p><u>Set Folder Alert Screen</u></p> <ul style="list-style-type: none"> • This screen lists all the message folders that are programmed into the device along with its alert setting to the right. Select the Inbox or folder you want to update and press button. • The Global Settings item appears if the pager has one or more Group folders. Their settings, along with those of the Inbox, can all be reset or updated at the same time.

SCREEN

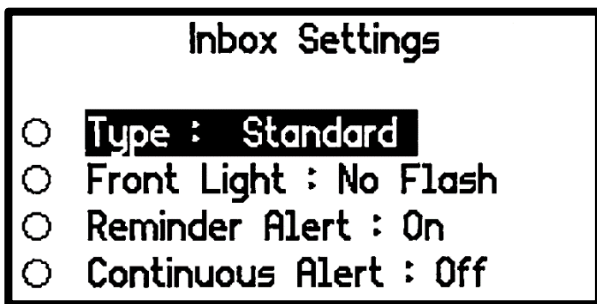
NOTES





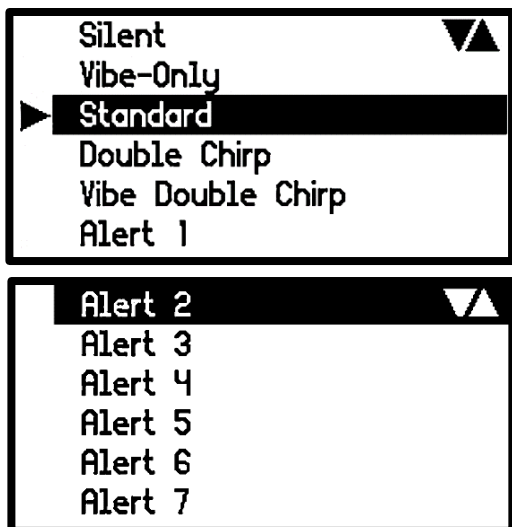

Message Folder Settings Screen

- Select the folder to update and press  button.
- Update the Type, Front Light, Reminder Alert and Continuous Alert option as desired. Highlight the option to edit and press  button. Select the desired option from the popup and press  button.





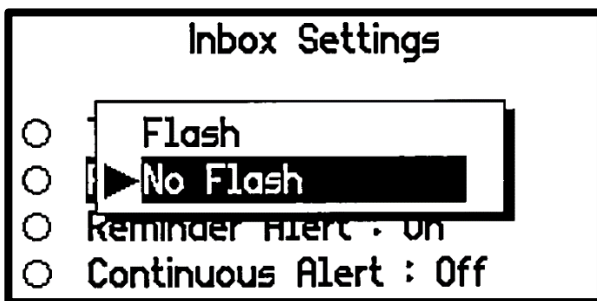

Set Type Setting Screen

- Press the  or  button to change Alert type.
- Press the  button to set the new Alert type.
- Press the  button to cancel the changed Alert type and exit back to the Message Folder Settings screen.





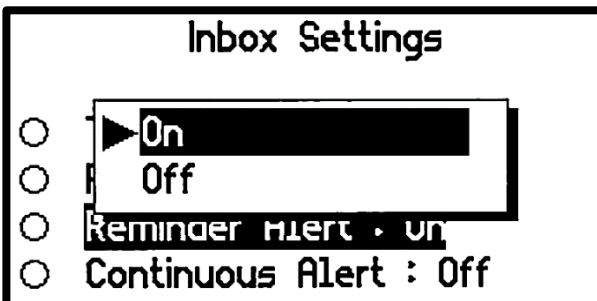

Set Front Light Setting Screen

- Press the  or  button to change selection.
- Press the  button to set the selection.
- Press the  button to remove the popup and return to the Message Folder Settings screen.



Reminder Alert Setting Screen



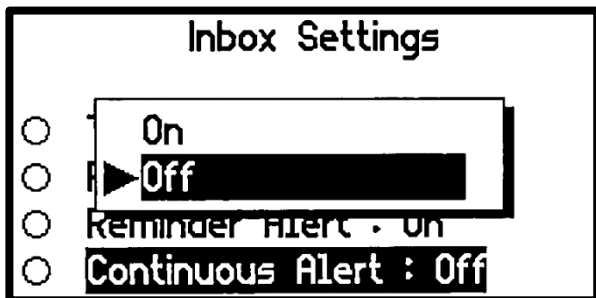

- Press the  or  button to change selection.
- Press the  button to set the selection.
- Press the  button to remove the popup and return to the Message Folder Settings screen.

SCREEN

NOTES



Continuous Alert Setting Screen

- Press the  or  button to change selection.
- Press the  button to set the selection.
- Press the  button to remove the popup and return to the Message Folder Settings screen.

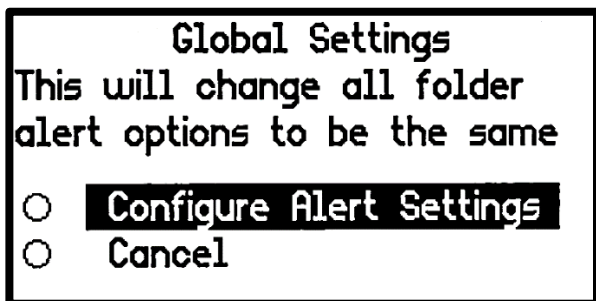

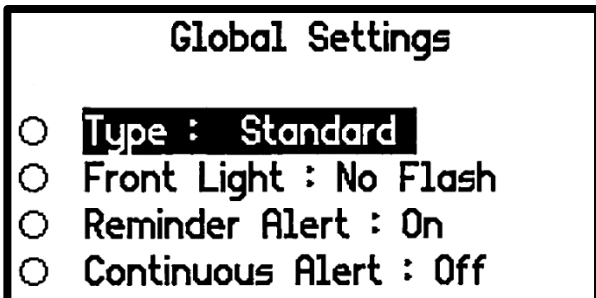

Global Settings Screens

From the Global Settings screen, select the Configure Alert Settings option and press the  button to bring up the alert settings screen where specific changes can be made.

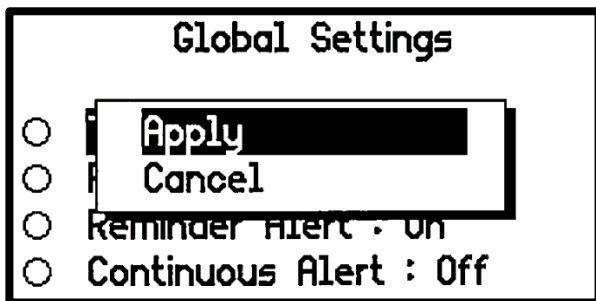

Update the alert settings as needed







After selecting the desired alert options, press the  button to bring up the Apply/Cancel popup.

- Selecting Apply will apply the settings to all your folders
- Selecting Cancel will return to the first Global Settings screen

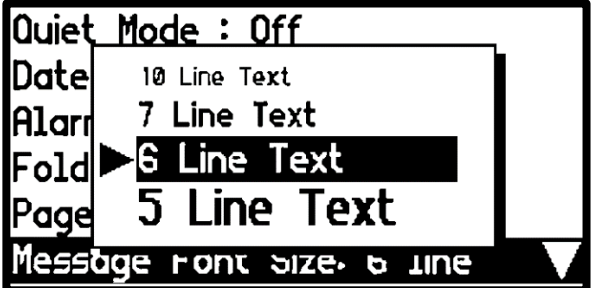
Set Message Font Size







Four different text sizes are supported for the message text in the message list and message view screens. Select the best 5, 6, 7 or 10 line text size for reading messages.

SCREEN	NOTES
	<p><u>Set Message Font Size Setting Popup</u></p> <ul style="list-style-type: none"> Set the text size of the message list, message read, group folder screens. Press the  or  button to select the desired text size. The current setting is indicated by the  icon.

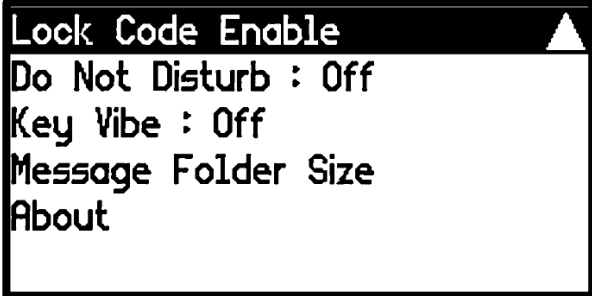
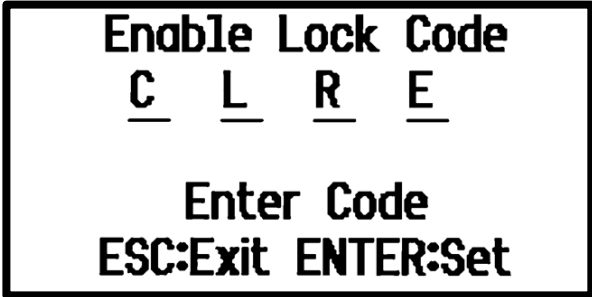
Set Lock Code

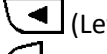
The Lock Code feature, when enabled by the user, prevents unauthorized persons from reading messages on the device. The message display will lock after the five-minute default inactivity period. To view messages, the user must enter the pre-defined four-button lock code sequence. All six device buttons can be used for the code.

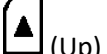
The lock code feature set is determined by device programming. For example, the lock code may be preset, without the option to change it, or the lock code may be changed but not disabled.

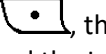
SCREEN	NOTES
	<p><u>Lock Code Enable Setting Screen</u></p> <ul style="list-style-type: none"> When the Lock Code is disabled, the 'Lock Code Enable' function is available.
	<p><u>Enable Lock Code Screen</u></p> <p>Press a sequence of four buttons to enter a code.</p> <ul style="list-style-type: none">  (ESC) = C,  (Enter) = E  (Left) = L,  (Right) = R  (Up) = U,  (Down) = D When the four buttons are entered, press  button to activate the Lock function. If you press , the Lock Code will be cancelled, and the Lock function will be disabled. In the Set Lock Code input window, you cannot cancel until four entries have been made.

SCREEN

NOTES

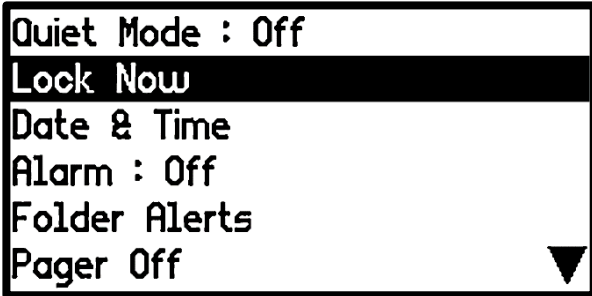

Lock Now Option

- Normally, when the Lock function is enabled, the Lock function operates after 5 minutes of button inactivity. The Lock Now function will immediately lock the device.

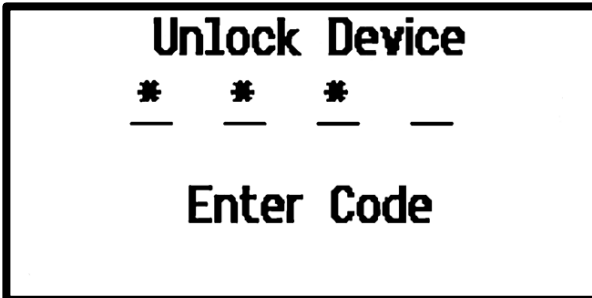

Unlock Device Screen

When the device is locked and a button is pressed from the Main screen, the Unlock Device input screen will appear. If the entered Lock Code is correct, the user can navigate the main screen and view messages. If the entered Lock Code is wrong, the main screen is displayed but Lock Code screen is displayed again when the user presses a button.

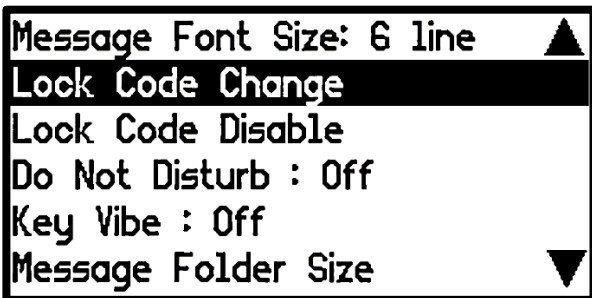

Change Lock Code

When the Lock Code feature is enabled, the 'Lock Code Change' function may be available for the user to change the lock code.

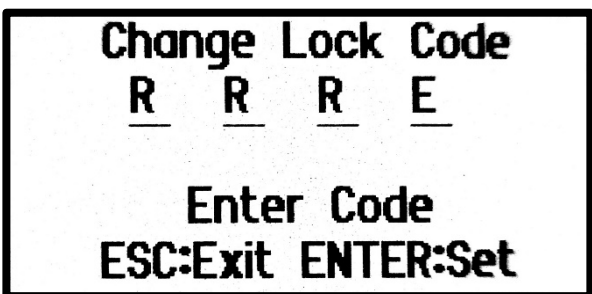

Change Lock Code Screen



- (ESC) = C, (Enter) = E
- (Left) = L, (Right) = R
- (Up) = U, (Down) = D
- When four code entries have been made, press button to activate the Lock function with the new lock code.
- If you press the Lock Code update will be cancelled.
- In the Change Lock Code input window, you cannot cancel the entry until four entries have been made.

SCREEN

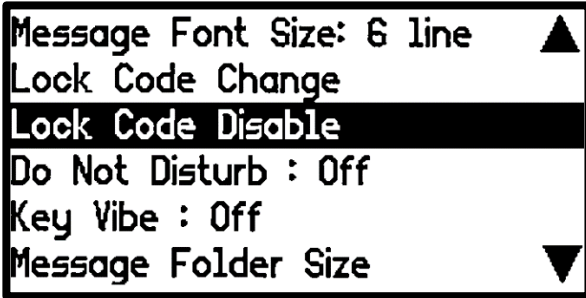
NOTES



Set Disable Lock Code

- When the Lock Code is enabled, the 'Lock Code Disable' function will be available if permitted by the pager.
- When the Lock Code is correct, press  button to disable the Lock feature. Pressing button  cancels the action.

If Lock Code is correct Screen

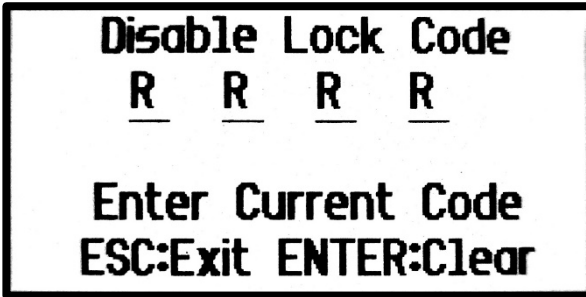

If Lock Code is incorrect Screen

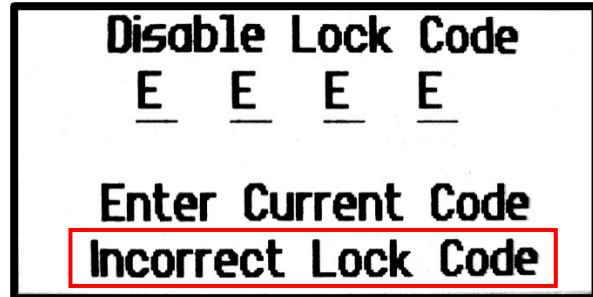

If you forget your lock code and can't access your pager, contact your organization's pager administrator to have it remotely reset.

Do Not Disturb

When the Do Not Disturb feature is enabled, the pager will not alert when a message is received between the set times. Typically, this feature is set during sleep time instead of turning the pager off. The pager will alert if a one-time or daily alarm expires or if a priority message is received. The pager can be set to alert at the end of the set time if a message was received.

SCREEN

NOTES

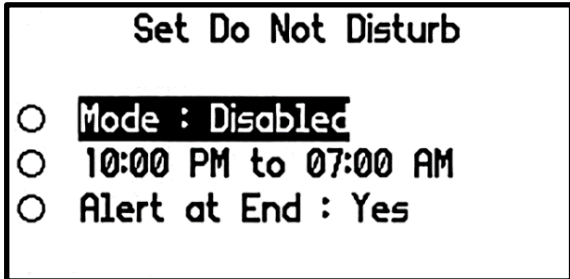

Set Do Not Disturb Menu Screen

- During the set do not disturb period, the pager will not alert (silent) if it receives a new message.
- Typically, the time range is set for a user's normal sleep time.

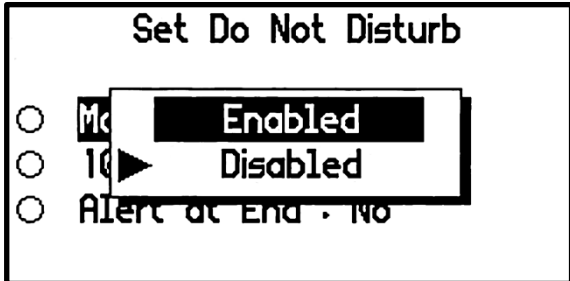

Mode Popup

- Select Enabled to enable the feature or select Disabled to disable the feature.

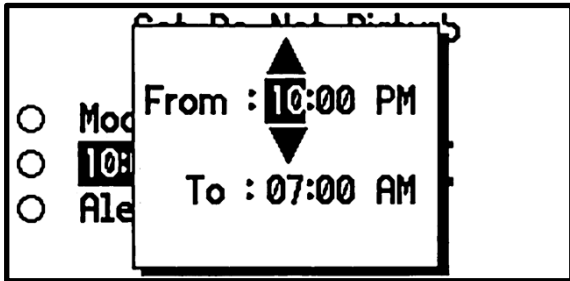

Time Setting Popup

Set the do not disturb start and end times in the same way that the Time & Date and Alarm Time settings were made.

Note:

- The From time is the feature start time.
- The To time is the feature end time.

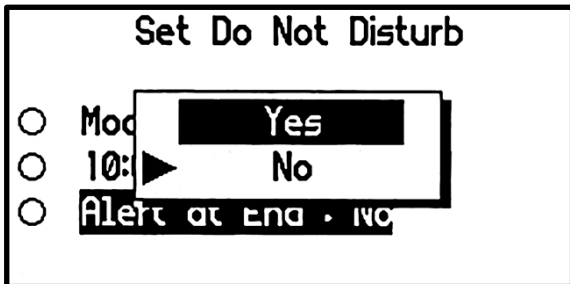

Alert at End Setting Popup

- Select Yes if the pager should alert at the end of the do not disturb period if a message was received during the period.
- Select No if the pager should not alert at the end of the do not disturb period.

Key Vibe

When Key Vibe is On, there is a very short vibration each time a key is pressed. (Haptic feedback)

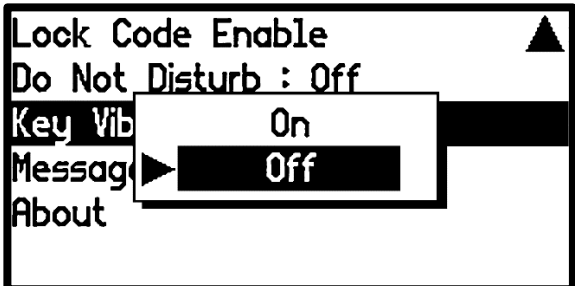
SCREEN	NOTES
	<p><u>Set Key Vibe Popup</u></p> <ul style="list-style-type: none"> This Pressing any key causes the pager to vibrate very briefly. This can help to confirm that the key has been pressed.



Message Folder Size

The Folder Size setting determines how many messages can be stored in the Inbox folder or a Groups sub-folder before messages are deleted as new messages are received. The size of each folder can be individually set. Once a folder is full of messages, messages will be automatically deleted as new messages arrive according to the following priority.

1. Read messages starting with the oldest
2. Unread messages starting with the oldest

Locked messages are not automatically deleted.

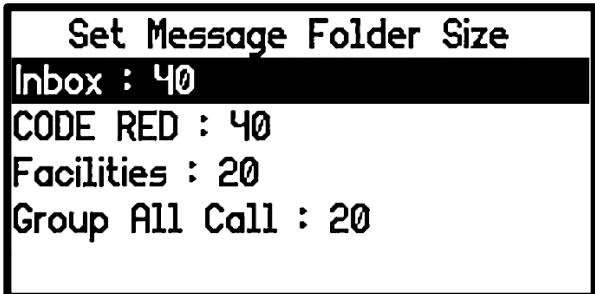
FOLDER TYPE	DETAIL
Inbox	The Inbox can hold a maximum of 99 messages and support limit increments of 20, 40, 60, 80 or 99 messages
Groups Sub-folders and Saved Folder	<p>Together, the Groups sub-folders and Saved folder can hold up to 100 messages. The Saved folder has a fixed maximum of 25 messages. Each Groups sub-folder can be set to hold a maximum of 20, 40, 60, 80 or 99 messages.</p> <p>NOTE: Groups sub-folders are optional and only appear if group folder addresses are programmed into the device with a sub-folder.</p>

SCREEN	NOTES
	<p><u>Set Message Folder Size Screen</u></p> <p>This screen shows all the message folders in the device and their current size setting. Select the folder you want to adjust the size for and press the  key to change the message limit.</p>

SCREEN

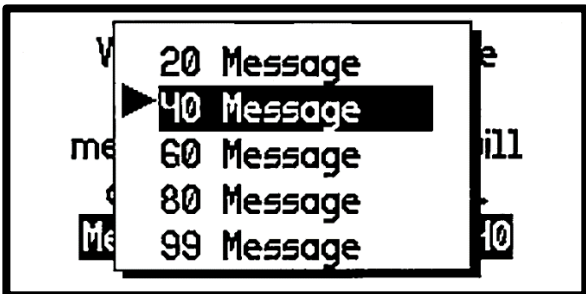





NOTES

Folder Size Warning Screen.

- If a folder size is reduced, the pager will reset and all messages in the folder will be deleted.
- Press the  key to start changing the folder message limit.

Changing number of messages.

- Press the  or  button to change the number of messages.
- Press the  button to set the changed number of messages.
- Press the  button to cancel the and exit back to the Set Message Folder Size screen.

The Groups sub-folders and the Saved folder have a combined capacity of 100. Then, if the device has five sub-folders with each set to 20, each sub-folder will contain a maximum of 20 messages. However, if the five sub-folders are each set to 40, each sub-folder would not be able to contain 40 messages ($5 \times 40 > 100$) and messages would be automatically deleted to maintain the Groups/Saved folder 100 message limit. Additionally, messages stored in the Saved folder (up to 25 messages) will take away from the 100-message limit.

Therefore, when a new message is received, message deletion will follow the following rules.

- IF FolderCount = Max
 - Delete oldest read, unlocked, message from the folder. If no read messages exist, delete oldest unread, unlocked, message from the folder
 - Store new message
- ELSEIF TotalCount = 100 – (Saved folder message count)
 - Delete oldest read, unlocked, message from all Groups folders. If no read messages exist, delete oldest unread, unlocked, message from all Groups folders.
 - Store new message

On-line Support

SCREEN

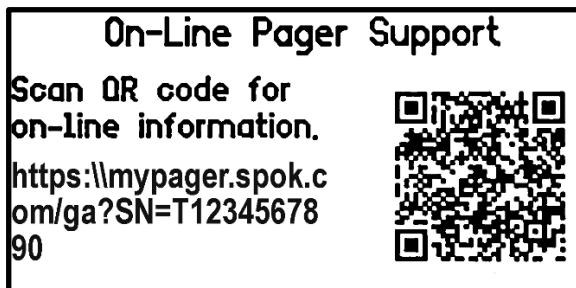

NOTES

On-Line Support Screen

The On-Line Support screen (if enabled) displays a QR code that can be scanned with a smartphone. The QR code contains a website URL with Spok GenA pager information and documents that can be accessed or downloaded with a smartphone.

- Quick Start Guide
- User Manual
- Data sheet

About

SCREEN

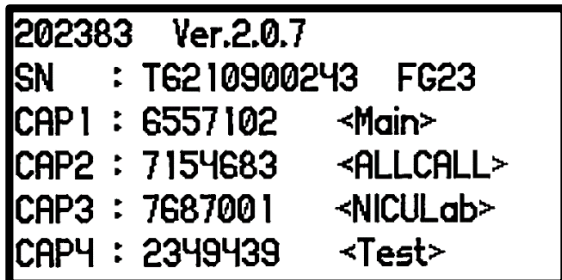

NOTES

About Screen

The About screen lists the following information:

- Firmware release information
- Device serial number
- A list of all the programmed device addresses (capcodes) and the address source text. An 'E' after the address indicates that messages to the address are encrypted